



Bon pour accord

Rehausse chanfreinée aération permanente

Document à nous renvoyer par télécopie au 03.23.21.79.76

| BON POUR ACCORD | | | | | | | | | | | | | | |
|------------------------------|---|---|---|--|---|---|---|---|---|---|---|---|---|---|
| Date d'envoi | | | | Date de validation | | | | | Société | | | | | |
| Expéditeur | | | | Nom du signataire, signature et cachet | | | | | ATTENTION : AUCUNE COMMANDE NE POURRA ETRE PRISE EN COMPTE SANS LE RETOUR DE CE DOCUMENT VALIDE PAR VOS SOINS. | | | | | |
| Destinataire | | | | | | | | | | | | | | |
| Vos références | | | | | | | | | | | | | | |
| Devis n° | | | | | | | | | | | | | | |
| | A | B | C | D | E | F | G | H | | J | K | L | M | N |
| Dimensions à remplir (en mm) | | | | | | | | | | | | | | |

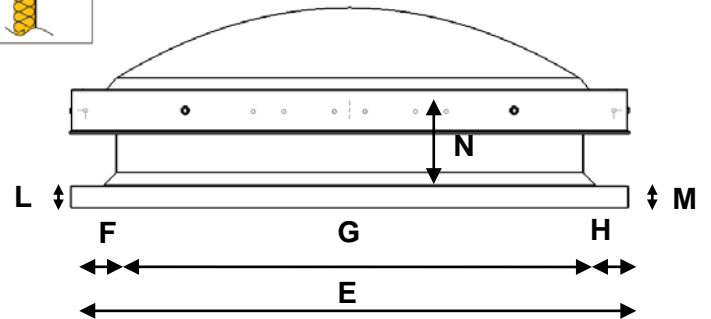
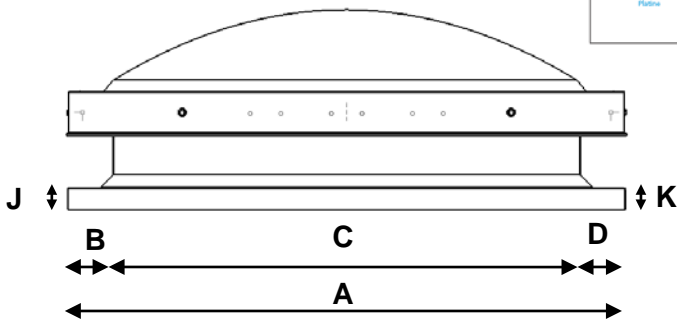
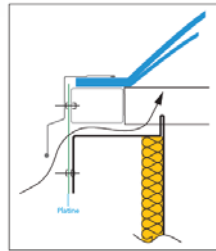
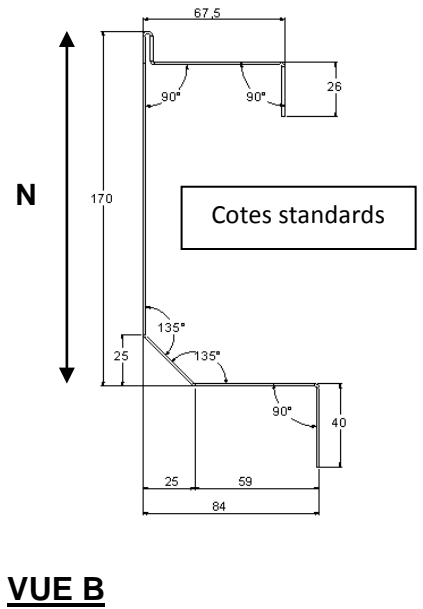
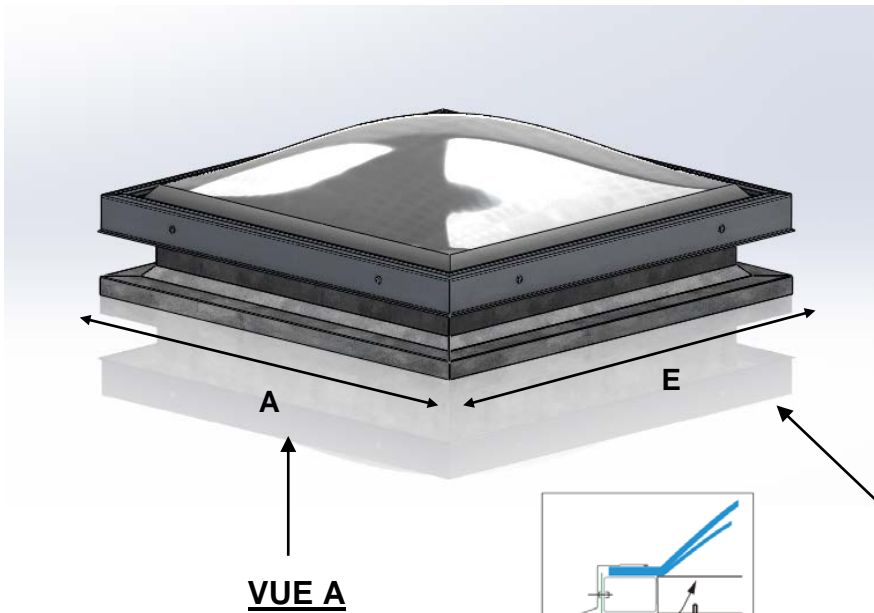

| | | | |
|--------------|---|--|--|
| Page 1 sur 1 | Bon pour accord Aération permanente rehausse chanfreinée MAJ : 10/09/2013 | SKYDÔME Entre-Deux-Villes 02270 SONS-ET-RONCHÈRES Tel: 0323217990 - Fax: 0323217976 | |
|--------------|---|--|--|



Bon pour accord

Costière type fixe aération permanente

Document à nous renvoyer par télécopie au **03.23.21.79.76**

| BON POUR ACCORD | | | | | | | | | | | | | | |
|------------------------------|---|---|---|--|---|---|---|---|---|---|--|--|--|--|
| Date d'envoi | | | | Date de validation | | | | | Société | | | | | |
| Expéditeur | | | | Nom du signataire, signature et cachet | | | | | ATTENTION : AUCUNE COMMANDE NE POURRA ETRE PRISE EN COMPTE SANS LE RETOUR DE CE DOCUMENT VALIDE PAR VOS SOINS. | | | | | |
| Destinataire | | | | | | | | | | | | | | |
| Vos références | | | | | | | | | | | | | | |
| Devis n° | | | | | | | | | | | | | | |
| | A | B | C | D | E | F | G | H | | N | | | | |
| Dimensions à remplir (en mm) | | | | | | | | | | | | | | |

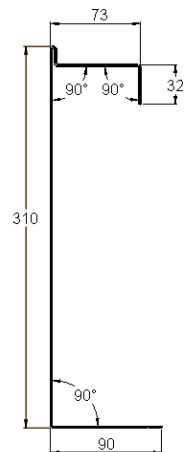
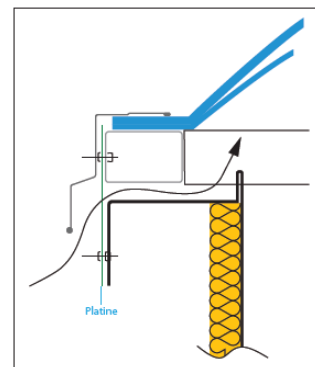
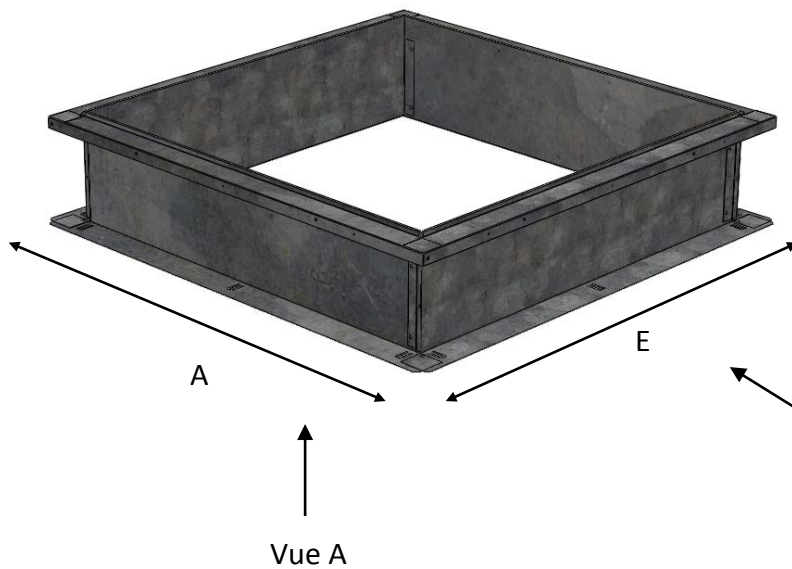

Cotes standards

